

1936 Bugatti Type 57SC Atlantic - RAB Replica

Engine & Transmission Mount Layout (Page 1 of 3)

Initiated September 25, 2006 - R. A. B.
 Last Revised July 8, 2007 - R. A. B.

Scale: 1/10

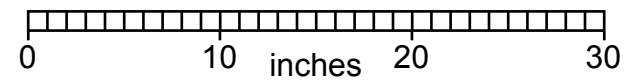

Ref. - Sheet	GA.	Strip/tube
.1495	9	.148
.1345	10	.134
.1196	11	.120
.1046	12	.109
.0747	14	.083
.0598	16	.065
.0478	18	.049
.0359	20	.035

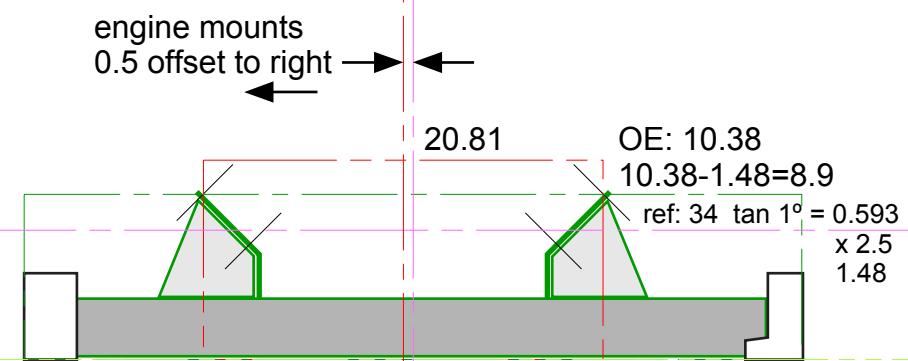
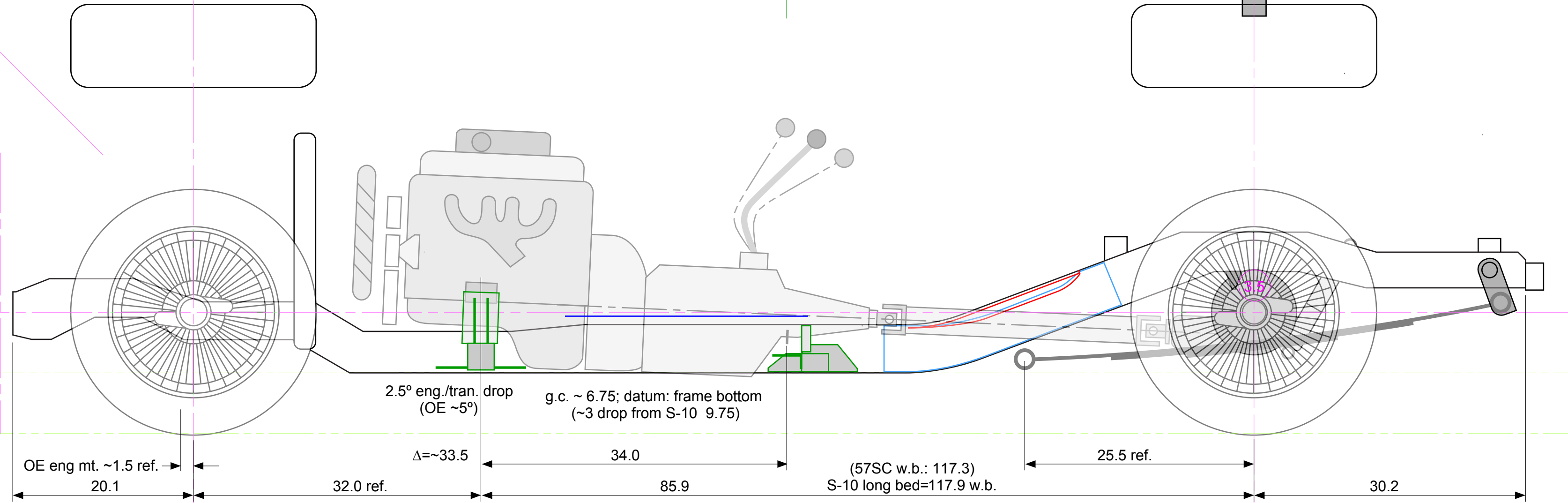
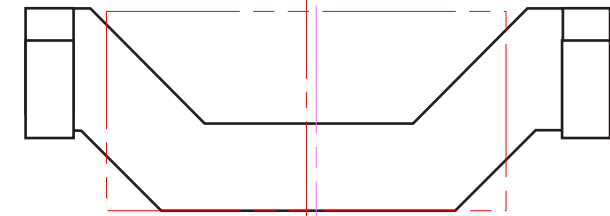
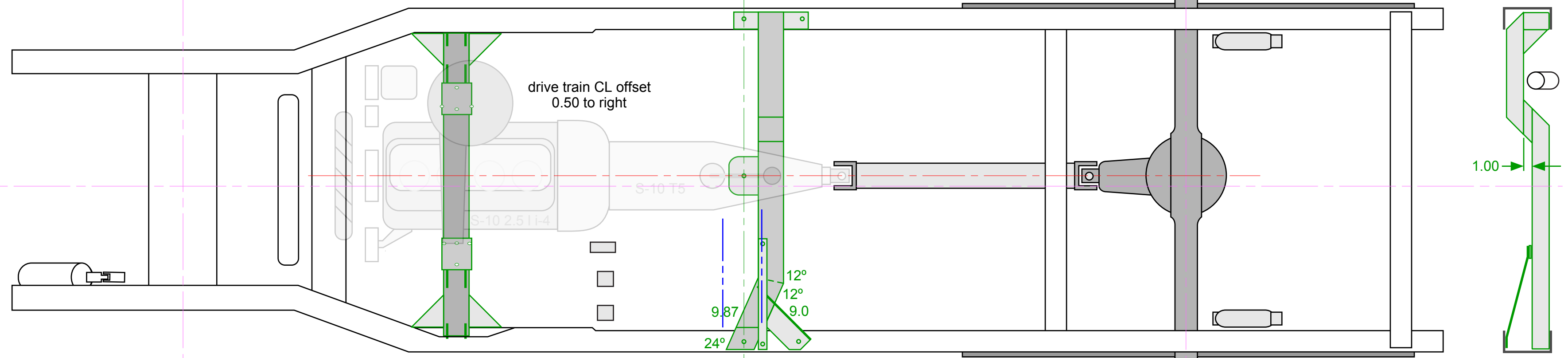

1936 Bugatti Type 57SC Atlantic - RAB Replica

Front Engine Mount - LEFT

(Page 2 of 3)

Last Revised October 27, 2006 - R. A. B.

Scale: full

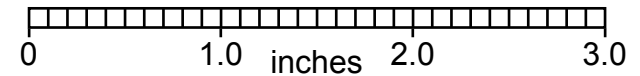

Ref. - Sheet	GA.	Strip/tube
.1495	9	.148
.1345	10	.134
.1196	11	.120
.1046	12	.109
.0747	14	.083
.0598	16	.065
.0478	18	.049
.0359	20	.035

LEFT

2.5° drop angle

A513 3 x 3 square tube

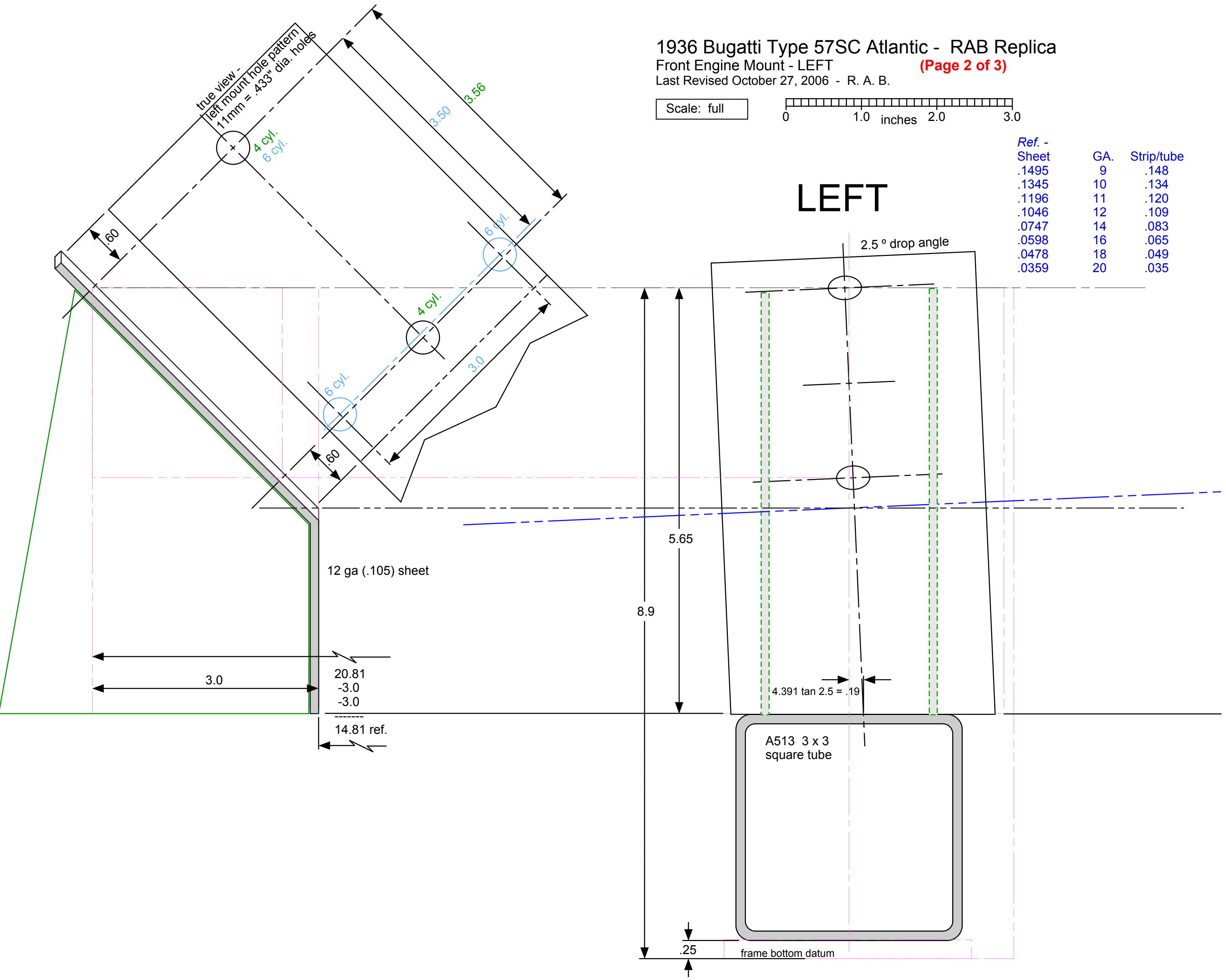

1991 S10n O.E. engine mount bolt hole pattern

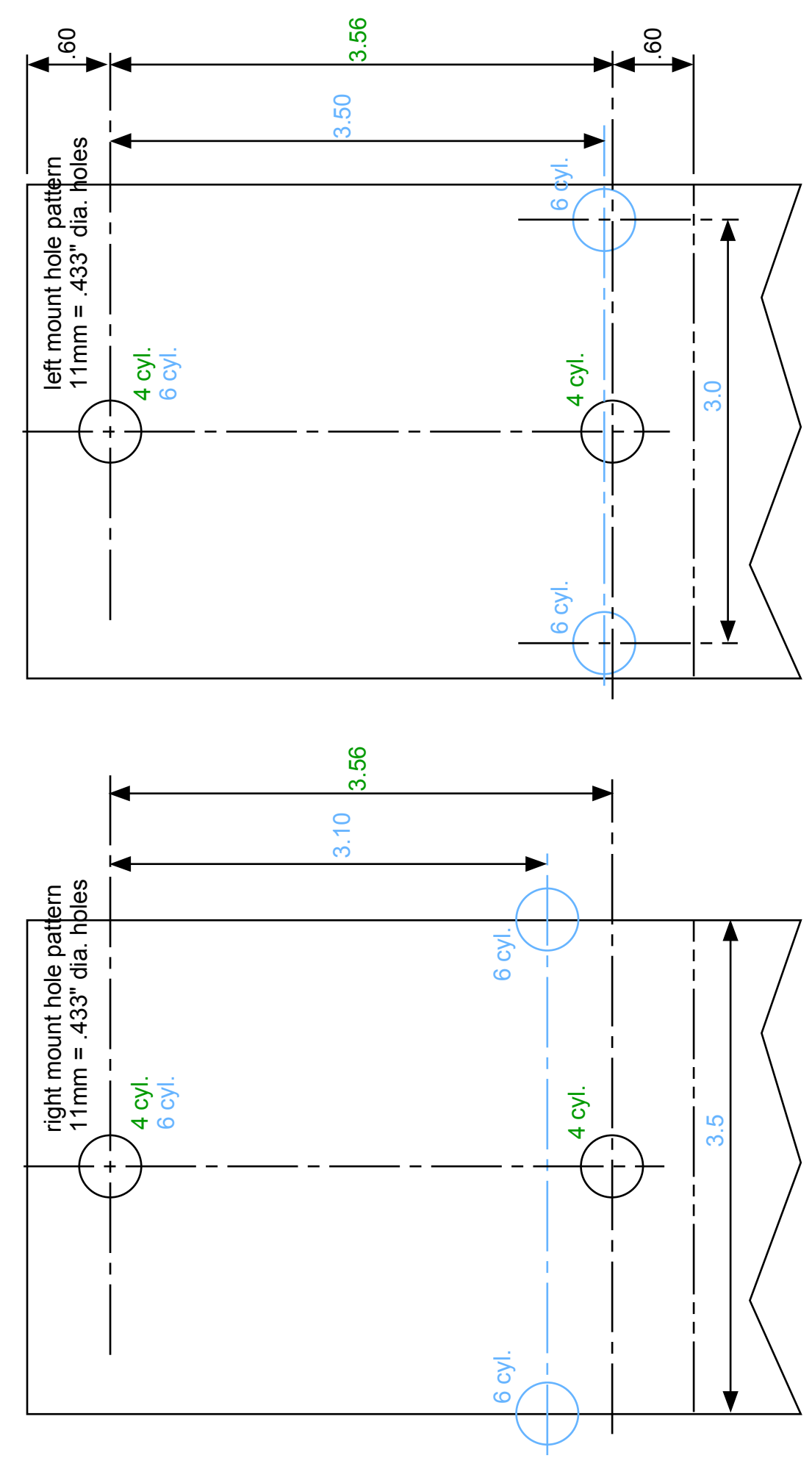

Scale: full

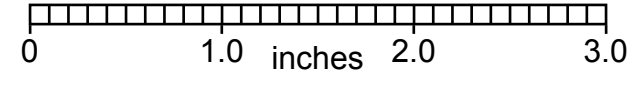

RIGHT

